

Manufacturer: SkyRC Technology Co., Ltd.
4, 5, 8 Floors, Building 4, Meitai Science Park, Guanguang Road,
Guanlan, Longhua District, Shenzhen, China.

制造商: 天空创新科技(深圳)有限公司
制造地址: 深圳市龙华区观澜街道桂花社区观光路美泰工业园4栋4,5,8层

 www.petoneer.com

V1.1

PETONEER
湃妮

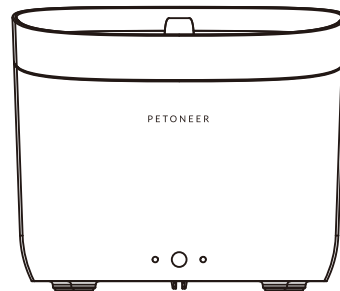

Fresco Mini Pro
User Manual

迷你宠物饮水机Pro
使用说明书

Model / 型号: WF001-M

Please read this manual carefully before using.
Keep the manual in a safe place for future reference.
使用产品前请仔细阅读本使用说明书并妥善保管

01 / Inside the box

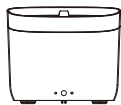

Fountain*1



Filter*1



Foam*1



Manual*1

02 / Meet Your Smart Fountain

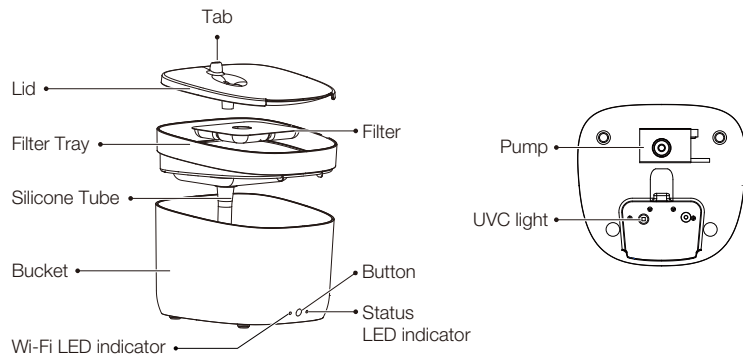

03 / Operations

① Clean up

Clean the inside of the bucket, the lid and the filter tray. Please clean the shell with a dry cloth.

Get the filter soaked inside the clean water for 5 minutes.

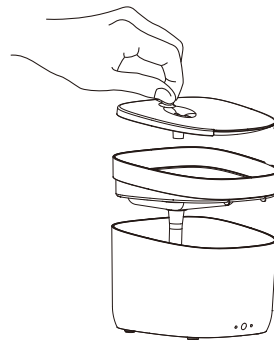

② Fill up

Pour water into the bucket. Do not exceed the max water level.

③ Assemble

Please put all parts in the right places according to the illustration;

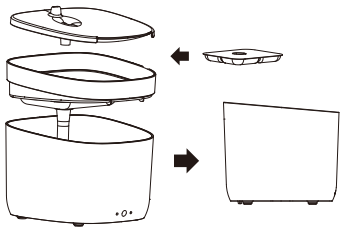

⑤ Accessories replacing

It is recommended to replace the filter, foam every 30 days.

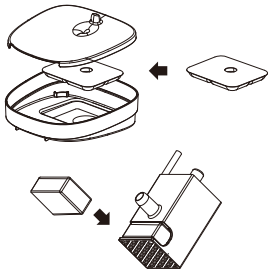

④ Power on

Connect the cable to the power adaptor, then plug it into to the wall outlet.

*The adaptor (USB 5V 1A) is not included; please find a spare one!

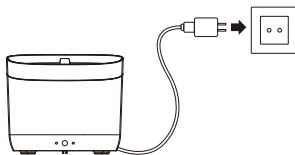

⑥ Connect the fountain

Download the MiHome app and connect the fountain to your Wi-Fi to monitor and control.

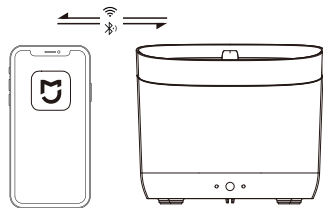

04 / Connect to the Mi Home app



Product QR Code

Integrated to Mijia, the unit can be controlled through the Mi Home app and work with some Mi Home products.

Scan the QR code to download and install the Mi Home app. Users with the Mi Home app will directly enter the device connection card.

Open the Mi Home app, click "+" in the upper right corner of the page, and get walked through to add devices.

Alternatively, you can search for Mi Home in the App Store or Google Play, download and install the Mi Home app.

Note:

"works with mijia" is only the certification at the software level. Xiaomi and the Mi Home are not responsible for the production, standard implementation, quality supervision, etc., of the product and the company.

Tips: Due to the upgrade and update of the Mi Home app, the actual operation may be slightly different from the above. Please follow the most current instructions in the Mi Home app.

05 / Declarations of Hazardous Substances in Electrical Appliances

Part Name	Toxic or hazardous Substances and Elements					
	Pb	Hg	Cd	Cr ⁶⁺	PBB	PBDE
BUCKET	O	O	O	O	O	O
FILTER TRAY	O	O	O	O	O	O
SILICONE TUBE	O	O	O	O	O	O
PUMP	O	O	O	O	O	O
PCB ASSEMBLY	O	O	O	O	O	O
WIRES	O	O	O	O	O	O

This form is compiled in accordance with SJ/T 11364.

O: Indicates that this toxic or hazardous substance contained in all the homogeneous materials for this part is below the limit requirement in GB/T 26125

X: Indicates that this toxic or hazardous substance contained in at least one of the homogeneous materials used for this part is above the limit requirement in GB/T 26125.

06 / Status Indicator Explained

Status Indicator LED	Meaning
Status LED steady on	Low Water
Status LED blinking in red	Filter Expired
Wi-Fi LED steady on	Connected
Wi-Fi LED flashing fast	Disconnected

07 / Specifications

Description: Fresco Mini Pro

Material: ABS

Communication: Wi-Fi(2.4GHz)

Model No.: WF001-M

Net Weight: 580g

Quality Directive: GB4706.1

CMIIT ID : 2019DP11626

Input Voltage: DC 5V 1A

Dimension: 174*181*154mm

Capacity: 1.9L

08 / Precautions

1. Please use it in the indoor environment;
2. DO DISCONNECT the power supply when cleaning. To clean the bucket, do not directly wash the outside of the bucket; when cleaning the whole unit, please clean the shell with a dry cloth.

- Do not look directly at the UVC light while it is working.
- After a period of UVC beaming, the yellowing inside the fountain is normal.
- Please place the unit on the flat ground to prevent accidental overturning, causing the fountain to sprinkle or not work correctly.
- Please shield or organize the power cord well to prevent the pet from biting the cable and causing dangerous situations such as electric shock;
- Low water reminder does not work if the fountain is not working. When there is water by default and the fountain is working, it will alert when water is detected low.
- This fountain is suitable for cats or small and medium-size dogs;

09 / Warranty Terms

Within the period of warranty, if the product fails with no fault of user operations, it will be repaired at Petoneer's expense. The warranty will not cover product failure in examples below:

- Intentional damage to the product by the user or third party
- Failure to operate or maintain the product following the (QIG) Quick Installation Guide Instructions.
- Failure by natural wear and tear including but not limited to scratching, corrosion, oxidation and rusting.
- Failure by non-authorized repair of the product including but not limited to user's own or third-party repairing attempts or modifications.

(All Pictures shown in the manual are for illustration purpose only.
Actual product may vary due to product enhancement.)

Note:

This product and after-sales service are only available in China (excluding Hong Kong, Macau and Taiwan).

This warranty is only applicable to China (excluding Hong Kong, Macau and Taiwan).

01 / 包装清单



饮水机 x 1



滤芯 x 1



海绵 x 1



说明书 x 1

02 / 产品概览

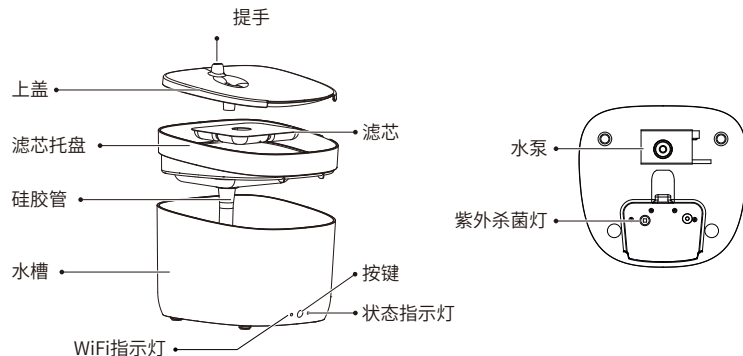

03 / 使用步骤

① 清洗

清洗水槽内部、上盖和滤芯托盘，水槽外壳请用干燥抹布进行清理。
请先用清水将滤芯浸泡5分钟备用

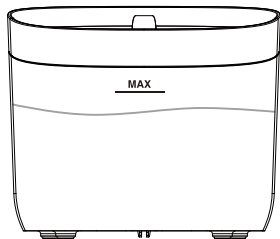
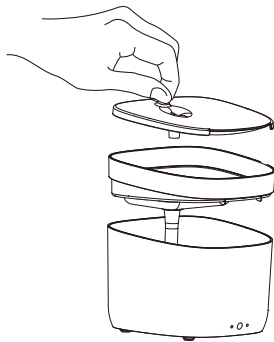

② 加水

将水倒入水槽中，加水量不要超过MAX水位线。

③ 组装

将滤芯托盘、滤芯、上盖依次组装后放入水槽中。

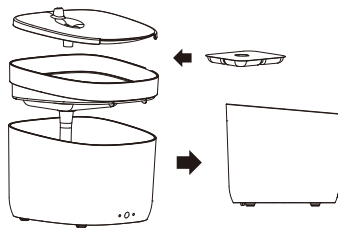

⑤ 更换耗材

建议每30天更换一次滤芯、海绵。

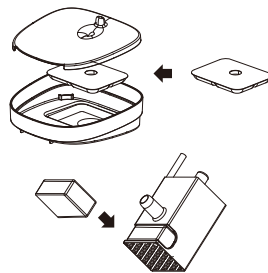

④ 连接电源

将水机电源线与适配器连接，并接通电源。

*本产品不提供电源适配器（USB 5V 1A），请自行配置。

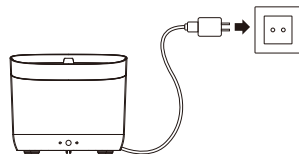

⑥ 添加设备

下载“米家”APP，添加设备，实时掌控水机状态。

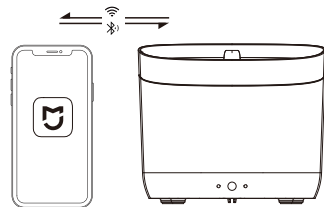

04 / 连接米家APP



产品二维码

本产品已接入米家，可通过米家APP操控，并与部分米家产品联动。

扫描二维码，下载并安装米家APP，已安装米家APP的用户将直接进入设备连接页。

或在应用商店搜索“米家(Mi Home)”，下载并安装米家(Mi Home)APP。打开米家(Mi Home)APP首页，在页面右上角点击“+”，根据APP提示方式添加设备。

提示：

由于米家APP的升级与更新，实际操作可能与以上描述略有差异，请按照当前米家APP内指引进行操作。

注意：“已接米家”（works with mijia）仅做软件层面的验证，小米及米家不对该产品及企业的生产制造、标准执行、质量监管等方面负责。

05 / 电子信息产品有害物质声明

部件名称	有毒有害物质或元素					
	Pb	Hg	Cd	Cr ⁶⁺	PBB	PBDE
水槽	○	○	○	○	○	○
滤芯托盘	○	○	○	○	○	○
硅胶管	○	○	○	○	○	○
水泵	○	○	○	○	○	○
电路板	○	○	○	○	○	○
线缆	○	○	○	○	○	○

本表格依据SJ/T 11364的规定编制。

○: 表示该有害物质在该部件所有均质材料中的含量均在GB/T 26125规定的限量要求以下。
X: 表示该有害物质至少在该部件的某一均质材料中的含量超出GB/T 26125规定的限量要求。

06 / 状态指示灯说明

指示灯	描述
状态指示灯红灯常亮	缺水
状态指示灯红灯闪烁	滤芯到期
Wi-Fi指示灯常亮	Wi-Fi已连接
Wi-Fi指示灯快闪	网络断开

07 / 基本参数

产品品名：迷你宠物饮水机Pro	产品材质：ABS	通讯方式：Wi-Fi(2.4GHz)
产品型号：WF001-M	产品净重：580g	执行标准：GB4706.1
CMII ID：2019DP11626	电源供电：DC 5V 1A	
产品尺寸：174*181*154mm	储水容量：1.9L	

08 / 注意事项

- 1.请在室内环境使用。
- 2.进行整机清理工作时，请断开电源，请勿直接冲洗水槽外壳；水槽外壳请用干燥抹布进行清理。

- 3.紫外杀菌灯亮起时请勿长时间直视。
- 4.经紫外线长期照射，UV灯四周发黄属正常现象。
- 5.请放置在水平地面上，以防不慎打翻，导致设备洒水或不正常工作。
- 6.请做好电源线遮挡或收纳，以防宠物撕咬电线。
- 7.缺水提醒在水机不工作时不检测不提醒，默认有水，工作时检测到缺水则提醒。
- 8.本机适用于猫或中小型犬。

09 / 保修条款

在保修期限内，对于正常使用Petoneer产品过程中，由于非人为导致的损坏，所产生的维修费用和 Related 的人工费用，由Petoneer承担。以下情况导致的维修不在保修条款包含中。

- (1) 故意行为导致的损坏。
- (2) 未按照产品使用说明书指引使用、保养该产品。
- (3) 设备正常磨损、腐蚀、氧化、锈垢、耗损等原因导致的损失。
- (4) 因在非Petoneer授权维修代理店或用户自身进行维修、改造、清洗而造成的损坏。

(为了更好的产品，我们会定期进行产品改良。产品实物可能与说明书有差异。)

注意：

本产品仅限中国地区（不含港澳台地区）销售，故本产品仅在中国地区（不含港澳台地区）提供售后服务，本保修条款仅适用于中国地区（不含港澳台地区）。